				Page Seite Sida
		10	12	16		
	90°	CTFP R/L	11	16	16	B121
	90°	CTGP R/L	11	16	16	B121
	85°	CSYP R/L	09 12	12		B122
	75°	CSKP R/L	09 12	12		B122
	75°	CSRP R/L	12	09 12		B123
	60°	CTTP R/L	16	11 16		B123
	60°	CTWP R/L	16	11 16		B124
	45°	CTSP R/L	16	11 16		B124
	45°	CSSP R/L		12	12	B125

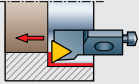

Size Grösse Storlek	10 CA	12 CA	16 CA
Type Typ Typ	CSKP CTWP - CSYP CTFP CTSP	CSKP CTWP CSSP CSYP CTFP CTSP	CSKP CTWP CSSP CSYP CTFP CTSP
D-min	40	50	60

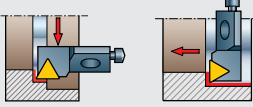

Size Grösse Storlek	10 CA	12 CA	16 CA
Type Typ Typ	CSRP - CTGP CTSP CTTP	CSRP CSSP CTGP CTSP CTTP	CSRP CSSP CTGP CTSP CTTP
D-min	40	50	60

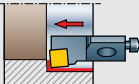
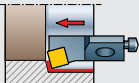
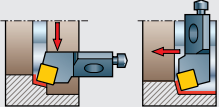
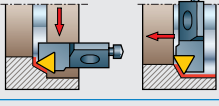
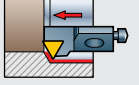
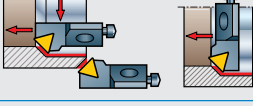
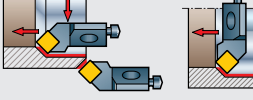
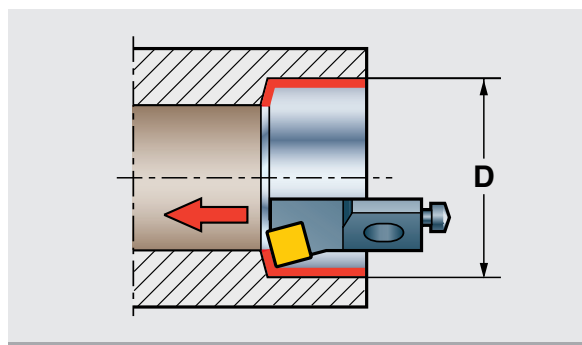
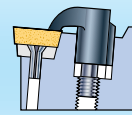
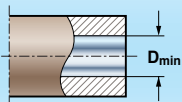
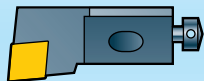
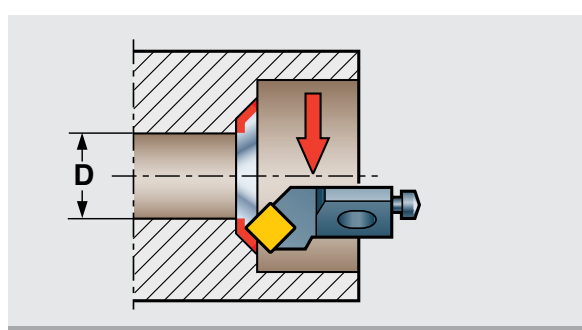
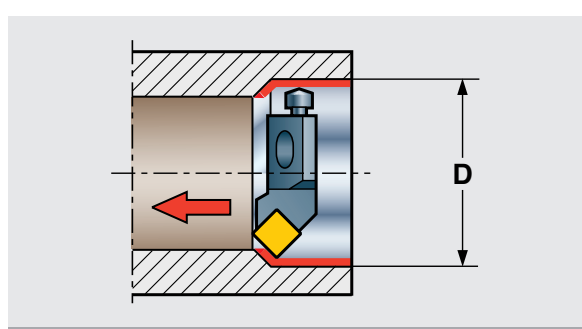

Size Grösse Storlek	10 CA	12 CA	16 CA
Type Typ Typ	CSRP - CTGP CTSP CTTP	CSRP CSSP CTGP CTSP CTTP	CSRP CSSP CTGP CTSP CTTP
D-min	55	75	75

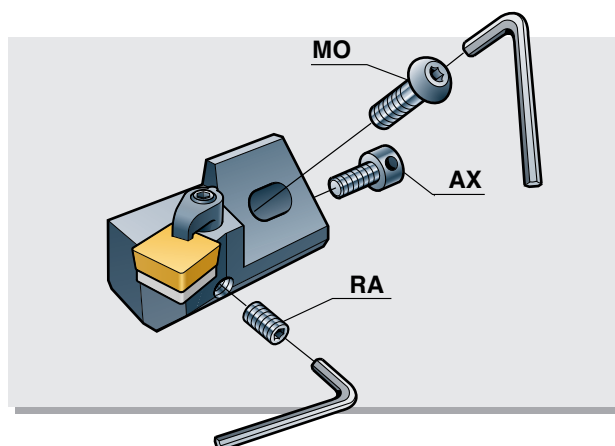

CTFP R/L

Recommendations
Empfehlungen
Rekommendationer

Page: Seite: Sida:

B9-B11, B16

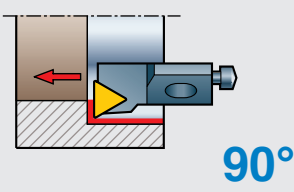



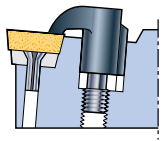





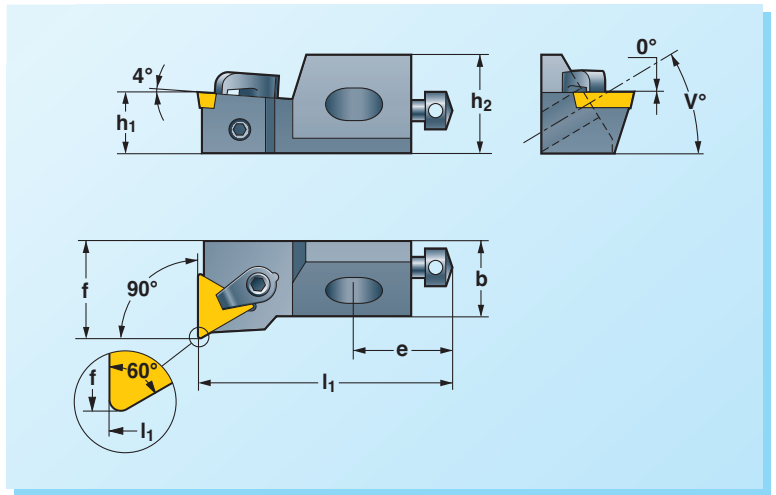

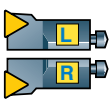
90°



C

The drawing shows right-hand version. Left-hand version reversed.
Die Zeichnung zeigt Rechtsausführung. Linksausführung umgekehrt.
Ritningen visar högerutförande. Vänsterutförande spegelvänt.



	h_1	h_2	b	l_1	e	f	v°											TPGN TPUN TPGR TPMR	Page: Seite: Sida: B147
CTFP R/L 10CA-11	10	15	11	50	20	14	20°	–	–	SH51	6S61K	NY3	AX508	RA408	NY2	MO618	NY4	1103 ..	
CTFP R/L 12CA-16	12	20	15	55	20	20	20°	–	–	SH51	6S61K	NY3	AX508	RA412	NY2	MO622	NY4	1603 ..	
CTFP R/L 16CA-16	16	21	20	63	25	25	45°	U323S	RS2	SH52K	6S62K1	NY4	AX612	RA512	NY2.5	MO830	NY5	1603 ..	

CTGP R/L

Recommendations
Empfehlungen
Rekommendationer

Page: Seite: Sida:

B9-B11, B16

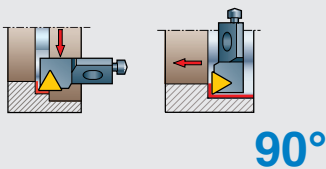



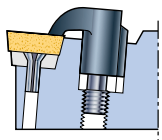





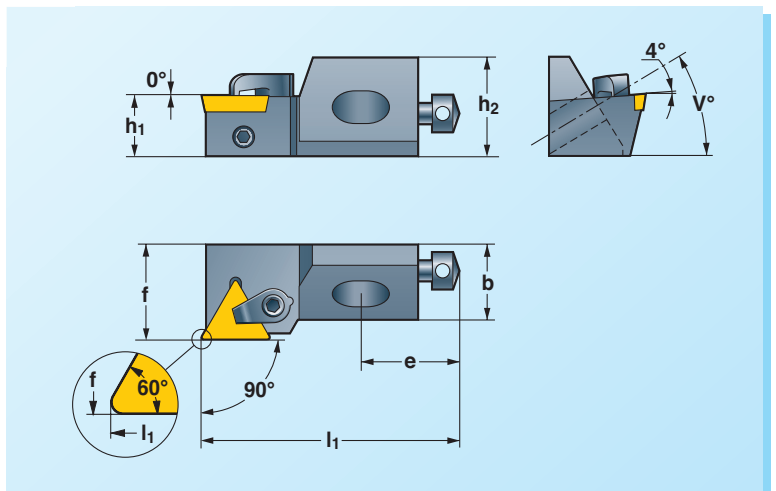

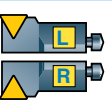
90°



C

The drawing shows right-hand version. Left-hand version reversed.
Die Zeichnung zeigt Rechtsausführung. Linksausführung umgekehrt.
Ritningen visar högerutförande. Vänsterutförande spegelvänt.



	h_1	h_2	b	l_1	e	f	v°											TPGN TPUN TPGR TPMR	Page: Seite: Sida: B147
CTGP R/L 10CA-11	10	15	11	50	20	14	20°	–	–	SH51	6S61K	NY3	AX508	RA408	NY2	MO618	NY4	1103	
CTGP R/L 12CA-16	12	20	15	55	20	20	20°	–	–	SH51	6S61K	NY3	AX508	RA412	NY2	MO622	NY4	1603 ..	
CTGP R/L 16CA-16	16	21	20	63	25	25	45°	U323S	RS207	SH52K	6S62K1	NY4	AX612	RA512	NY2.5	MO830	NY5	1603 ..	

Ordering example:

Bestellbeispiel: **CTGPR 16CA-16**

Beställningsexempel:

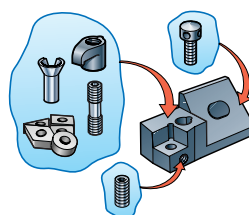

Spare parts shown in the coloured columns are supplied assembled in each tool.

Die in den farbigen Spalten aufgeführten Ersatzteile sind in den Werkzeugen montiert.

Reservdelar i de färgade kolumnerna ingår monterade i varje verktyg.

CSYP R/L

Recommendations
Empfehlungen
Rekommendationer

Page: Seite: Sida:

B9-B11, B16

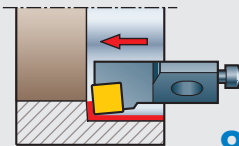



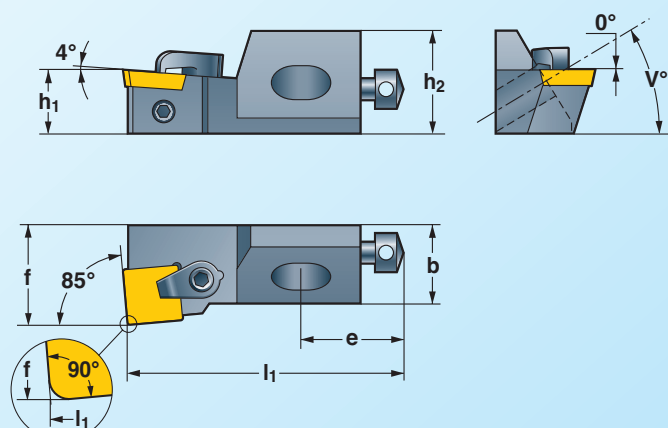
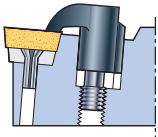





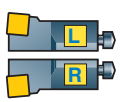

85°

C

The drawing shows right-hand version. Left-hand version reversed.
Die Zeichnung zeigt Rechtsausführung. Linksausführung umgekehrt.
Ritningen visar högerutförande. Vänsterutförande spegelvänt.

	h_1	h_2	b	l_1	e	f	v°											SPGN SPUN SPGR SPMR	Page: Seite: Sida: B147
CSYP R/L 10CA-09	10	15	11	50	20	14	20°	-	-	SH51	6S61K	NY3	AX508	RA408	NY2	MO618	NY4	0903 ..	
CSYP R/L 12CA-12	12	20	15	55	20	20	20°	-	-	SH51	6S61K	NY3	AX508	RA412	NY2	MO622	NY4	1203 ..	
CSYP R/L 16CA-12	16	21	20	63	25	25	45°	U424S	RS2	SH52K	6S62K1	NY4	AX612	RA512	NY2.5	MO830	NY5		

CSKP R/L

Recommendations
Empfehlungen
Rekommendationer

Page: Seite: Sida:

B9-B11, B16

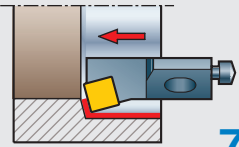



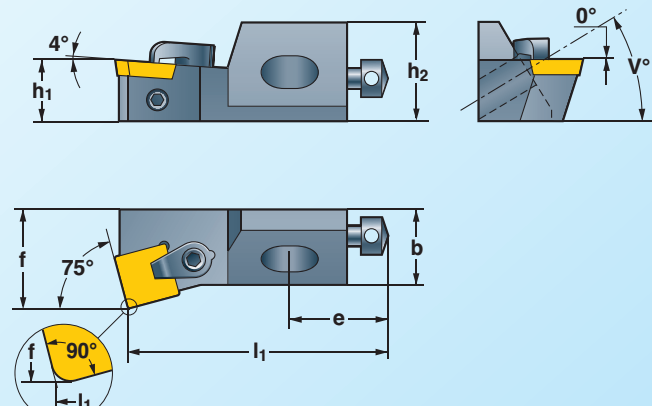
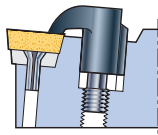





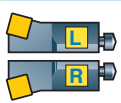

75°

C

The drawing shows right-hand version. Left-hand version reversed.
Die Zeichnung zeigt Rechtsausführung. Linksausführung umgekehrt.
Ritningen visar högerutförande. Vänsterutförande spegelvänt.

	h_1	h_2	b	l_1	e	f	v°											SPGN SPUN SPGR SPMR	Page: Seite: Sida: B147
CSKP R/L 10CA-09	10	15	11	50	20	14	20°	-	-	SH51	6S61K	NY3	AX508	RA408	NY2	MO618	NY4	0903 ..	
CSKP R/L 12CA-12	12	20	15	55	20	20	20°	-	-	SH51	6S61K	NY3	AX508	RA412	NY2	MO622	NY4	1203 ..	
CSKP R/L 16CA-12	16	21	20	63	25	25	45°	U424S	RS2	SH52K	6S62K1	NY4	AX612	RA512	NY2.5	MO830	NY5		

CSRP R/L

Recommendations
Empfehlungen
Rekommendationer

Page: Seite: Sida:

B9-B11, B16

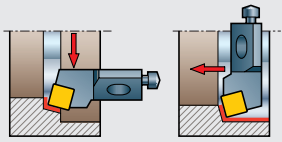



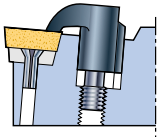





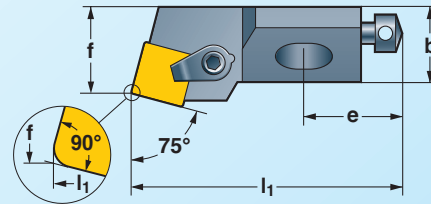
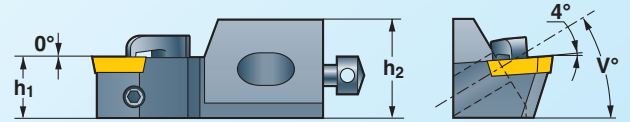



75°



C

The drawing shows right-hand version. Left-hand version reversed.
Die Zeichnung zeigt Rechtsausführung. Linksausführung umgekehrt.
Ritningen visar högerutförande. Vänsterutförande spegelvänt.



	h_1	h_2	b	l_1	e	f	v°											SPGN SPUN SPGR SPMR	Page: Seite: Sida: B147
CSRP R/L 10CA-09	10	15	11	50	20	14	20°	-	-	SH51	6S61K	NY3	AX508	RA408	NY2	MO618	NY4	0903 . .	
CSRP R/L 12CA-12	12	20	15	55	20	20	20°	-	-	SH51	6S61K	NY3	AX508	RA412	NY2	MO622	NY4	1203 . .	
CSRP R/L 16CA-12	16	21	20	63	25	25	45°	U424S	RS2	SH52K	6S62K1	NY4	AX612	RA512	NY2.5	MO830	NY5		

CTTP R/L

Recommendations
Empfehlungen
Rekommendationer

Page: Seite: Sida:

B9-B11, B16

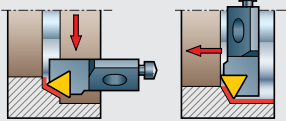



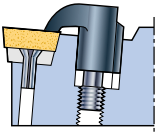





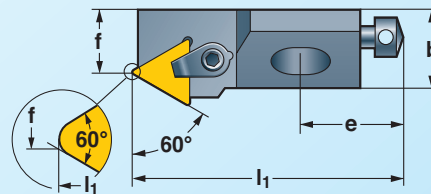
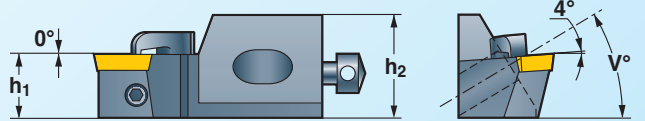

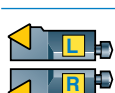
60°



C

The drawing shows right-hand version. Left-hand version reversed.
Die Zeichnung zeigt Rechtsausführung. Linksausführung umgekehrt.
Ritningen visar högerutförande. Vänsterutförande spegelvänt.



	h_1	h_2	b	l_1	e	f	v°											TPGN TPUN TPGR TPMR	Page: Seite: Sida: B147
CTTP R/L 10CA-11	10	15	11	50	20	9	20°	-	-	SH51	6S61K	NY3	AX508	RA408	NY2	MO618	NY4	1103 . .	
CTTP R/L 12CA-16	12	20	15	55	20	13	20°	-	-	SH51	6S61K	NY3	AX508	RA412	NY2	MO622	NY4	1603 . .	
CTTP R/L 16CA-16	16	21	20	63	25	15	45°	U323S	RS207	SH52K	6S62K1	NY4	AX612	RA512	NY2.5	MO830	NY5		

Ordering example:

Bestellbeispiel: **CSRPP 10CA-09**

Beställningsexempel:

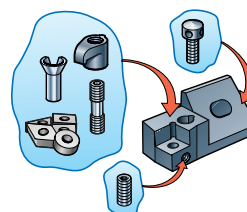

Spare parts shown in the coloured columns are supplied assembled in each tool.

Die in den farbigen Spalten aufgeführten Ersatzteile sind in den Werkzeugen montiert.

Reservdelar i de färgade kolumnerna ingår monterade i varje verktyg.

CTWP R/L

Recommendations
Empfehlungen
Rekommendationer

Page: Seite: Sida:

B9-B11, B16

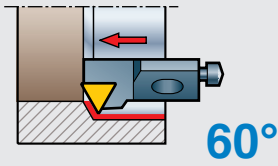

60°

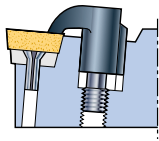

C

The drawing shows right-hand version. Left-hand version reversed.
Die Zeichnung zeigt Rechtsausführung. Linksausführung umgekehrt.
Ritningen visar högerutförande. Vänsterutförande spegelvänt.

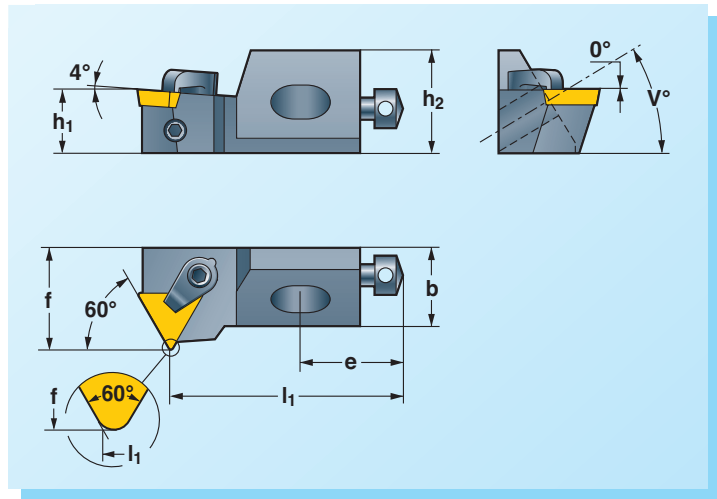

	h_1	h_2	b	l_1	e	f	v°											TPGN TPUN TPGR TPMR	Page: Seite: Sida: B147
CTWP R/L 10CA-11	10	15	11	44	20	14	20°	-	-	SH51	6S61K	NY3	AX508	RA408	NY2	MO618	NY4	1103 ..	
CTWP R/L 12CA-16	12	20	15	47	20	20	20°	-	-	SH51	6S61K	NY3	AX508	RA412	NY2	MO622	NY4	1603 ..	
CTWP R/L 16CA-16	16	21	20	53	25	25	45°	U323S	RS2	SH52K	6S62K1	NY4	AX612	RA512	NY2.5	MO830	NY5		

CTSP R/L

Recommendations
Empfehlungen
Rekommendationer

Page: Seite: Sida:

B9-B11, B16

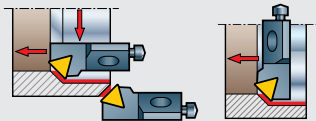

45°

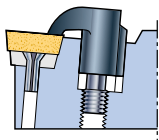

C

The drawing shows right-hand version. Left-hand version reversed.
Die Zeichnung zeigt Rechtsausführung. Linksausführung umgekehrt.
Ritningen visar högerutförande. Vänsterutförande spegelvänt.

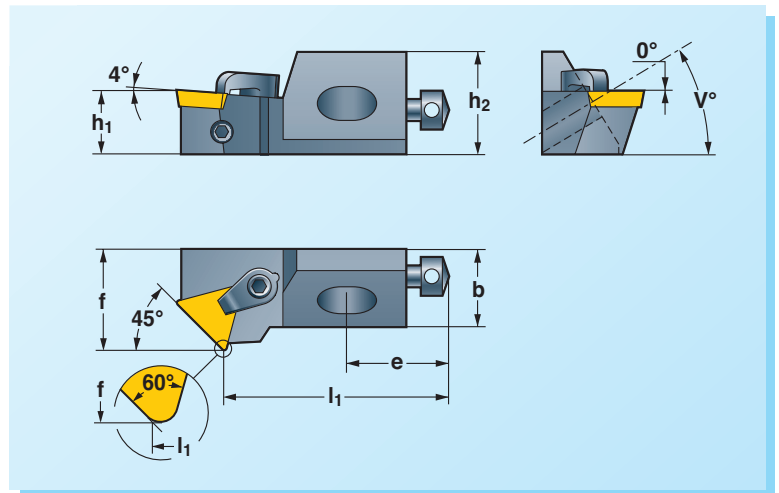

	h_1	h_2	b	l_1	e	f	v°											TPGN TPUN TPGR TPMR	Page: Seite: Sida: B147
CTSP R/L 10CA-11	10	15	11	44	20	14	20°	-	-	SH51	6S61K	NY3	AX508	RA408	NY2	MO618	NY4	1103 ..	
CTSP R/L 12CA-16	12	20	15	47	20	20	20°	-	-	SH51	6S61K	NY3	AX508	RA412	NY2	MO622	NY4	1603 ..	
CTSP R/L 16CA-16	16	21	20	53	25	25	45°	U323S	RS207	SH52K	6S62K1	NY4	AX612	RA512	NY2.5	MO830	NY5		

CSSP R/L

Recommendations
Empfehlungen
Rekomendationer

Page: Seite: Sida:

B9-B11, B16

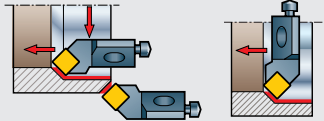

45°

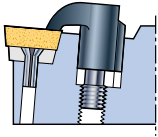

C

The drawing shows right-hand version. Left-hand version reversed.
Die Zeichnung zeigt Rechtsausführung. Linksausführung umgekehrt.
Ritningen visar högerutförande. Vänsterutförande spegelvänt.

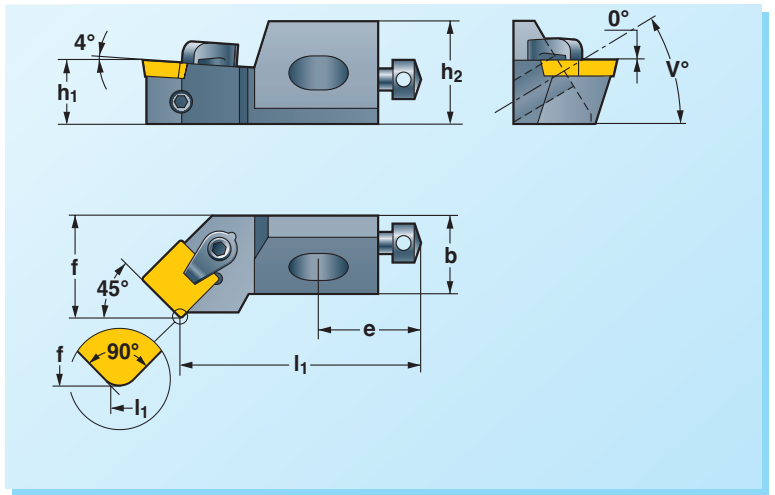

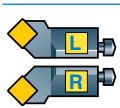
	h ₁	h ₂	b	l ₁	e	f	v°	Spare parts										Page: Seite: Sida: B147
								U424S	RS2	SH51	6S61K	NY3	AX508	RA412	NY2	MO622	NY4	
CSSP R/L 12CA-12	12	20	15	47	20	20	20°	-	-	SH51	6S61K	NY3	AX508	RA412	NY2	MO622	NY4	1203 . .
CSSP R/L 16CA-12	16	21	20	53	25	25	45°	U424S	RS2	SH52K	6S62K1	NY4	AX612	RA512	NY2.5	MO830	NY5	

Ordering example:

Bestellbeispiel: **CSSPR 12CA-12**

Beställningsexempel:

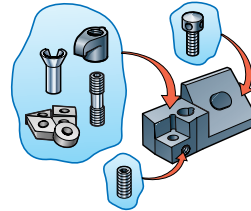

Spare parts shown in the coloured columns are supplied assembled in each tool.

Die in den farbigen Spalten aufgeführten Ersatzteile sind in den Werkzeugen montiert.

Reservdelar i de färgade kolumnerna ingår monterade i varje verktyg.