

SCLC R/L

Recommendations
Empfehlungen
Rekomendationer

Page: Seite: Sida:

B12-B14, B18

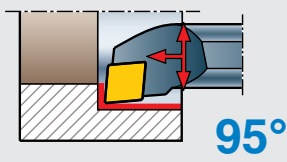

95°

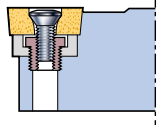

S

The drawing shows right-hand version. Left-hand version reversed.
Die Zeichnung zeigt Rechtsausführung. Linksausführung umgekehrt.
Ritningen visar högerutförande. Vänsterutförande spegelvänt.

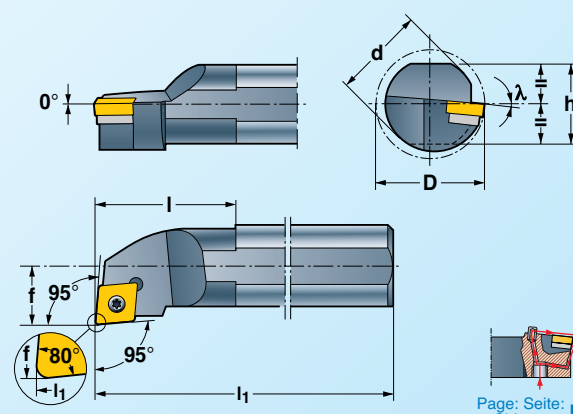

EB

Page: Seite: Sida: **B24 - B26**

	d	h	l ₁	l	f	D _{min}	λ		torx				CCMW * CCMT CCXT	Page: Seite: Sida: B179-B184
S08K-SCLC R/L 06	8	7	125	20	5	11	-11°	FTX072505						
S10L-SCLC R/L 06	10	9	140	20	7	13	-11°	FTX072507	NY7X	-	-	-	0602 ..	
S12N-SCLC R/L 06	12	11	160	25	9	16	-15°	FTX072507						
S16R-SCLC R/L 09M	16	15	200	30	11	20	-12°	FTX154008						
S20S-SCLC R/L 09M	20	18	250	35	13	25	-8°	FTX154010	NY15X	-	-	-	09T3 ..	
S25T-SCLC R/L 09M	25	23	300	45	17	32	-6°	FTX154010						
S32U-SCLC R/L 12	32	30	350	50	22	40	-12°	FTX154515	NY15X	UCC12	RSM610	NY4.5	1204 ..	

SWLC R/L

Recommendations
Empfehlungen
Rekomendationer

Page: Seite: Sida:

B12-B14, B18

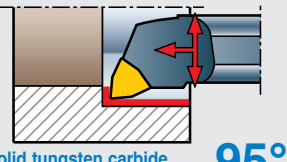

95°

E = Solid tungsten carbide
E = Massives Hartmetall
E = Solid hårdmetall

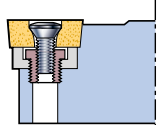

S

The drawing shows right-hand version. Left-hand version reversed.
Die Zeichnung zeigt Rechtsausführung. Linksausführung umgekehrt.
Ritningen visar högerutförande. Vänsterutförande spegelvänt.

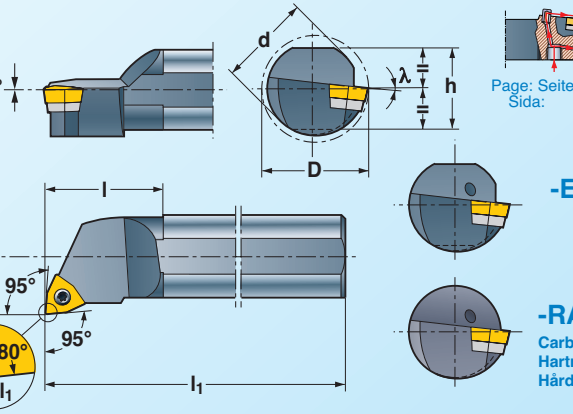

EB

Page: Seite: Sida: **B24 - B26**

-EB

-RA
Carbide shank
Hartmetallschaft
Hårdmetallskaft

	d	h	l ₁	l	f	D _{min}	λ		torx				WCMW * WCMT WCGT	Page: Seite: Sida: B179-B184
S10L-SWLC R/L 04	10	9	140	20	7	13	-11°	FTX072507	NY7X	-	-	-	0402 ..	
S12N-SWLC R/L 04	12	11	160	25	9	16	-12°							
S16R-SWLC R/L 06	16	15	200	30	11	20	-7°	FTX154010	NY15X	-	-	-	06T3 ..	
S20S-SWLC R/L 06	20	18	250	35	13	25	-5°							
S25T-SWLC R/L 08	25	23	300	45	17	32	-5°	FTX154512	NY15X	-	-	-	0804 ..	
A08H-SWLC R/L 02/6-EB	8	7	100	20	2,9	6	-17°	FTX062003	NY6X	-	-	-	0201 ..R/L ¹⁾	
A08H-SWLC R/L 02/8-EB	8	7	100	20	4	8	-12°						0201 ..	
A08H-SWLC R/L 04-EB	8	7	100	20	5	10	-11°	FTX072505	NY7X	-	-	-	0402 ..	
A10K-SWLC R/L 04-EB	10	9	125	20	7	13	-12°	FTX072505	NY7X	-	-	-		
A12M-SWLC R/L 04-EB	12	11	150	25	9	16	-12°							
A16M-SWLC R/L 06-EB	16	15	150	30	11	20	-7°	FTX154010	NY15X	-	-	-	06T3 ..	
A20Q-SWLC R/L 06-EB	20	18	180	30	13	25	-5°							
A25R-SWLC R/L 08-EB	25	23	200	40	17	32	-5°	FTX154512	NY15X	-	-	-	0804 ..	
E08K-SWLC R/L 04-RA	8	-	125	12	5	10	-11°	FTX072505	NY7X	-	-	-	0402 ..	
E10M-SWLC R/L 04-RA	10	-	150	12	7	13	-11°	FTX072507	NY7X	-	-	-		
E12Q-SWLC R/L 04-RA	12	-	180	12	9	16	-12°							
E16R-SWLC R/L 06-RA	16	-	200	12	11	20	-7°	FTX150410	NY15X	-	-	-	06T3 ..	

1) Left-hand inserts (L) are used in right-hand holders and right-hand inserts (R) are used in left-hand holders.

1) Linksschneiden (L) werden in Rechtshaltern und Rechtsschneiden (R) in Linkshaltern verwendet.

1) Vänsterskär (L) används i högerhållare och högerskär (R) i vänsterhållare.

SDUC R/L

Recommendations
Empfehlungen
Rekommendationer

Page: Seite: Sida:
B12-B14, B18

$\leq 27^\circ$

93°

E = Solid tungsten carbide
E = Massives Hartmetall
E = Solid hårdmetall

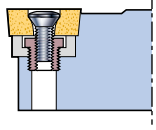

S

The drawing shows right-hand version. Left-hand version reversed.
Die Zeichnung zeigt Rechtsausführung. Linksausführung umgekehrt.
Ritningen visar högerutförande. Vänsterutförande spegelvänt.

EB

Page: Seite: Sida: **B24 - B26**

-EB
-RAM
Carbide shank
Hartmetallschaft
Hårdmetallskaft

B

	d	h	l ₁	l	f	D _{min}	λ						DCMW * DCMT DCXT	Page: Seite: Sida: B179-B184
S12N-SDUC R/L 07 S16R-SDUC R/L 07 S20S-SDUC R/L 07	12 16 20	11 15 18	160 200 250	20 30 35	9 11 13	17 20 25	-11° -5° -5°	FTX072507	torx NY7X	-	-	-	0702 ..	
S20S-SDUC R/L 11 S25T-SDUC R/L 11 S32U-SDUC R/L 11	20 25 32	18 23 30	250 300 350	35 45 50	13 17 22	25 32 40	-5° -5° -12°	FTX154010 FTX153514	NY15X NY15X	- UDC11	- RSM508	- NY3.5	11T3 ..	
A10K-SDUC R/L 07-EB A12M-SDUC R/L 07-EB A16M-SDUC R/L 07-EB	10 12 16	9 11 15	125 150 150	20 20 30	7 9 11	13 17 20	-15° -11° -5°	FTX072505 FTX072507	NY7X NY7X	- -	- -	- -	0702 ..	
A20Q-SDUC R/L 11-EB A25R-SDUC R/L 11-EB	20 25	18 23	180 200	25 35	13 17	25 32	-5° -5°	FTX154010	NY15X	-	-	-	11T3 ..	
E10M-SDUC R/L 07-RAM E12Q-SDUC R/L 07-RAM E16R-SDUC R/L 07-RAM	10 12 16	- - -	150 180 200	23 26 32	9 11 13	15 18 22	-7° -5° -5°	FTX072505 FTX072507	NY7X NY7X	- -	- -	- -	0702 ..	

EB = Adapted for micro lubrication system

E = Carbide shank
R = Cylindrical shank
A = Through coolant

EB = Für Minimalmengenschmiersystem angepasst

E = Hartmetallschaft
R = Cylindrisches Schaft
A = Innenkühlmittelführung

EB = Anpassad för minimalsmjörssystem

E = Hårdmetallskaft
R = Cylindriskt skaft
A = Invändig kylvätsketillförsel

SDXC R/L

Recommendations
Empfehlungen
Rekommendationer

Page: Seite: Sida:
B12-B14, B18

$\leq 30^\circ$

93°

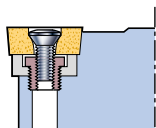

S

The drawing shows right-hand version. Left-hand version reversed.
Die Zeichnung zeigt Rechtsausführung. Linksausführung umgekehrt.
Ritningen visar högerutförande. Vänsterutförande spegelvänt.

EB

Page: Seite: Sida:
B179-B184

	d	h	l ₁	l ₂	f	D _{min}	λ			DCMW * DCMT DCXT	Page: Seite: Sida: B179-B184
S12Q-SDXC R/L 07T S16R-SDXC R/L 07T S20S-SDXC R/L 07T	12 16 20	11 15 18	180 200 250	25 30 35	9 11 13	17 20 25	-5° -5° -5°	FTX072507	torx NY7X	- 0702 ..	
S25T-SDXC R/L 11T	25	23	300	50	17	32	-5°	FTX153510	NY15X	- 11T3 ..	

SVUC R/L
SVUB R/L

Recommendations
Empfehlungen
Rekommendationer

Page: Seite: Sida:
B12-B14, B18

47°
93°

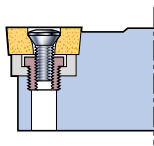

S

The drawing shows right-hand version. Left-hand version reversed.
Die Zeichnung zeigt Rechtsausführung. Linksausführung umgekehrt.
Ritningen visar högerutförande. Vänsterutförande spegelvänt.

0°
93°
35°
-EB
EB

Page: Seite: Sida:
B24 - B26

	d	h	l ₁	l	f	D _{min}	λ							Page: Seite: Sida: B179-B184
A16M-SVUC R/L 11M-EB	16	15	150	20	13	22	-7°							VBMT * VCMT VCGT VCXT
A20Q-SVUC R/L 11M-EB	20	18	180	25	15	27	-5°	FTX072507	torx					VCM_1103 . .
A25R-SVUC R/L 11M-EB	25	23	200	30	18	33	-3°							
S32U-SVUB R/L 16	32	30	350	50	22	40	-12°	FTX153514	NY15X	UVB16	RSM508	NY3,5		VBM_/VCM_1604 . .

EB = Adapted for microlubrication system

A = Through coolant

EB = Für Minimalmengenschmiersystem angepasst

A = Innenkühlmittelzuführung

EB = Anpassad för minimalsmörjsystem

A = Invändigt kylvätsketillförsel

STFC R/L

Recommendations
Empfehlungen
Rekommendationer

Page: Seite: Sida:
B12-B14, B18

91°

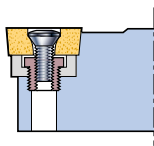

S

The drawing shows right-hand version. Left-hand version reversed.
Die Zeichnung zeigt Rechtsausführung. Linksausführung umgekehrt.
Ritningen visar högerutförande. Vänsterutförande spegelvänt.

0°
91°
60°

	d	h	l ₁	l	f	D _{min}	λ						Page: Seite: Sida: B179-B184
S10L-STFC R/L 09	10	9	140	20	7	13	-15°	FTX072206	torx				TCMW * TCMT TCGT
S12N-STFC R/L 11	12	11	160	25	9	16	-10°						
S16R-STFC R/L 11	16	15	200	30	11	20	-6°	FTX072507	NY7X				1102 . .
S20S-STFC R/L 11	20	18	250	35	13	25	-3°						
S25T-STFC R/L 16	25	23	300	45	17	32	-6°	FTX154010	NY15X				16T3 . .

*



Selection of cutting geometry page:
Wahl der Schneidgeometrie, Seite:
Val av skärgeometri, sid:

B27-B39

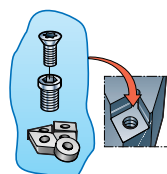

Spare parts shown in the coloured columns are supplied assembled in each tool.

Die in den farbigen Spalten aufgeführten Ersatzteile sind in den Werkzeugen montiert.

Reservdelar i de färgade kolumnerna ingår monterade i varje verktyg.

Ordering example:

Bestellbeispiel:

S12Q-SDXCL 07T

Beställningsexempel:

SCFC R/L

Recommendations
Empfehlungen
Rekommendationer

Page: Seite: Sida:

B12-B14, B18

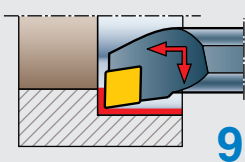

91°

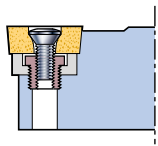

S



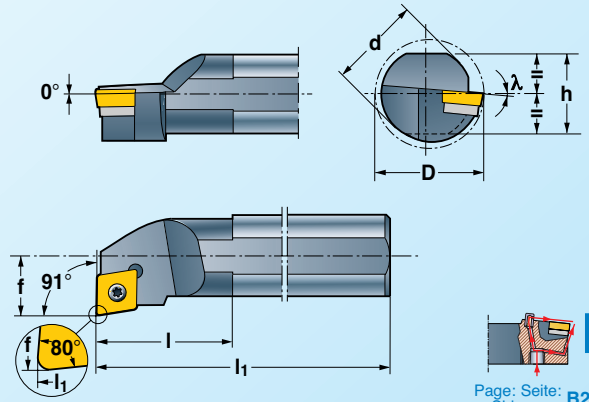

The drawing shows right-hand version. Left-hand version reversed.
Die Zeichnung zeigt Rechtsausführung. Linksausführung umgekehrt.
Ritningen visar högerutförande. Vänsterutförande spegelvänt.



EB

Page: Seite: **B24 - B26**
Sida:

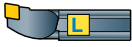
B

	d	h	l ₁	l	f	D _{min}	λ			CCMW * CCMT CCXT	Page: Seite: Sida: B179-B184
 											
S08K-SCFC R/L 06	8	7	125	20	5	10	-11°	FTX072505			
S10L-SCFC R/L 06	10	9	140	20	7	13	-11°	FTX072507	NY7X	0602 . .	
S12N-SCFC R/L 06	12	11	160	25	9	16	-15°	FTX072507			
S16R-SCFC R/L 09M	16	15	200	25	11	20	-12°	FTX154010	NY15X	09T3 . .	
S20S-SCFC R/L 09M	20	18	250	35	13	25	-8°	FTX154010	NY15X	09T3 . .	

SCFC R/L



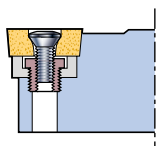

Solid tungsten carbide
Massives Hartmetall
Solid hårdmetall

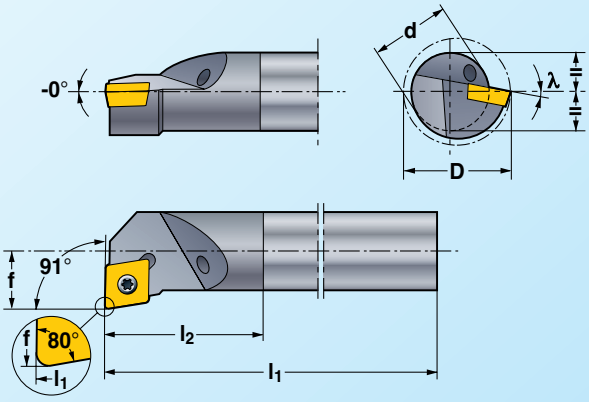

S

The drawing shows right-hand version. Left-hand version reversed.
Die Zeichnung zeigt Rechtsausführung. Linksausführung umgekehrt.
Ritningen visar högerutförande. Vänsterutförande spegelvänt.



	d	l ₁	f	l ₂	D _{min}	λ			CCMW * CCMT CCXT	Page: Seite: Sida: B179-B184
 										
E08K-SCFCR/L 06-RA	8	125	5	18	10	-11°	FTX072505			
E10M-SCFCR/L 06-RA	10	150	7	23	13	-11°	FTX072505	NY7X	0602 . .	
E12Q-SCFCR/L 09-RA	12	180	9	26	17	-11°	FTX154010	NY15X	09T3 . .	
E16R-SCFCR/L 09-RA	16	200	11	32	20	-7°	FTX154010	NY15X	09T3 . .	

A = Through coolant
R = Cylindrical shank

A = Innenkühlmittelzuführung
R = Zylindrisches Schaft

A = Invändig kylvätsketillförsel
R = Cylindriskt skaft

SSKC R/L

Recommendations
Empfehlungen
Rekommendationer

Page: Seite: Sida:
B12-B14, B18

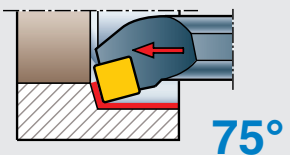



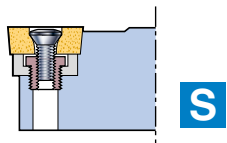



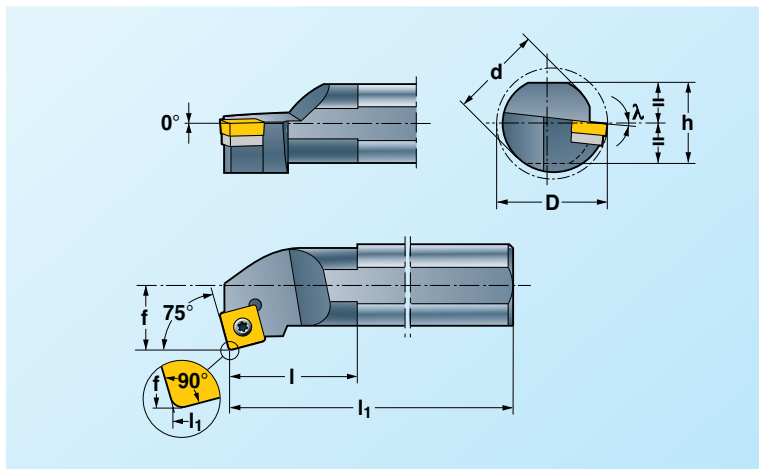





75°



The drawing shows right-hand version. Left-hand version reversed.
Die Zeichnung zeigt Rechtsausführung. Linksausführung umgekehrt.
Ritningen visar högerutförande. Vänsterutförande spegelvänt.



	d	h	l ₁	l	f	D _{min}	λ			SCMW * SCMT SCGT   	Page: Seite: Sida: B179-B184
 										SCMW * SCMT SCGT   	Page: Seite: Sida: B179-B184
S16R-SSKC R/L 09M S20S-SSKC R/L 09M	16 20	15 18	200 250	30 35	11 13	20 25	-11° -6°	FTX153512	NY15X	09T3 . .	

SSSC R/L

Recommendations
Empfehlungen
Rekommendationer

Page: Seite: Sida:
B12-B14, B18

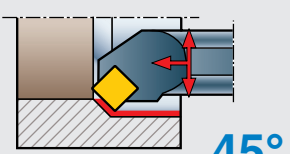



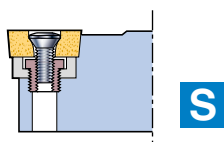



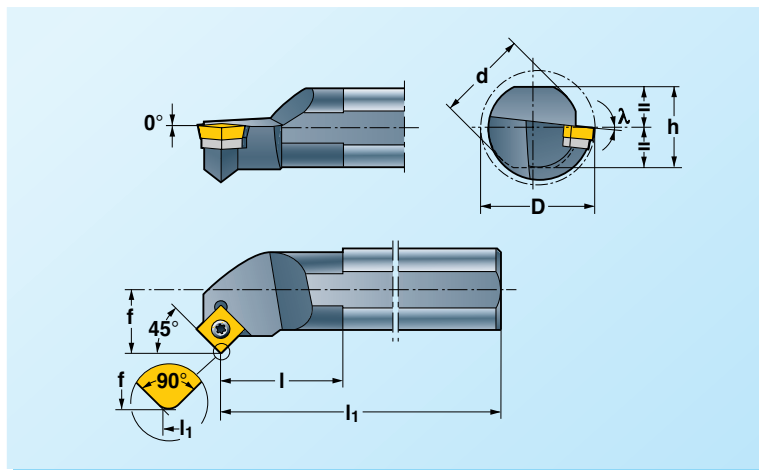













45°



The drawing shows right-hand version. Left-hand version reversed.
Die Zeichnung zeigt Rechtsausführung. Linksausführung umgekehrt.
Ritningen visar högerutförande. Vänsterutförande spegelvänt.



	d	h	l ₁	l	f	D _{min}	λ						SCMW * SCMT SCGT   	Page: Seite: Sida: B179-B184
 													SCMW * SCMT SCGT   	Page: Seite: Sida: B179-B184
S16R-SSSC R/L 09 S20S-SSSC R/L 09 S25T-SSSC R/L 09	16 20 25	15 18 23	200 250 300	30 35 45	11 13 17	21 25 32	-5° -5° -5°	FTX153512	NY15X	-	-	-	09T3 . .	
S32U-SSSC R/L 12	32	30	350	50	22	40	-12°	FTX154515	NY15X	USC12	RSM610	NY4,5	1204 . .	

*  Selection of cutting geometry page:
Wahl der Schneidgeometrie, Seite: **B27-B39**
 Val av skärgeometri, sid:

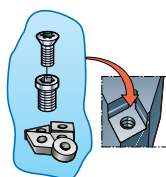

Spare parts shown in the coloured columns are supplied assembled in each tool.



Die in den farbigen Spalten aufgeführten Ersatzteile sind in den Werkzeugen montiert.

Reservdelar i de färgade kolumnerna ingår monterade i varje verktyg.

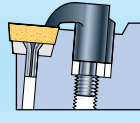
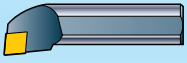
Ordering example:
Bestellbeispiel: **S20S-SSSCR 09**
Beställningsexempel:

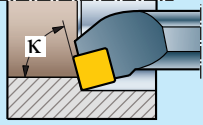

B

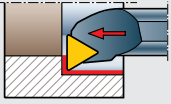
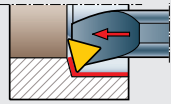
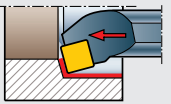
												Page Seite Sida
		8	10	12	16	20	25	32	40	50	60	
 91°	CTFC R/L	06										B115
	CTFP R/L		09	11	11	16	16	16	22	22	22	B115
 75°	CTKC R/L	06										B115
	CTKP R/L		09									B115
 75°	CSKP R/L			09	09	12	12	12	19	19	19	B116

CTFC R/L CTFP R/L

Recommendations
Empfehlungen
Rekommendationer

Page: Seite: Sida:

B12-B14, B19

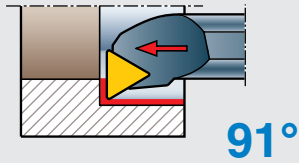

91°

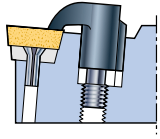

C

The drawing shows right-hand version. Left-hand version reversed.
Die Zeichnung zeigt Rechtsausführung. Linksausführung umgekehrt.
Ritningen visar högerutförande. Vänsterutförande spegelvänt.

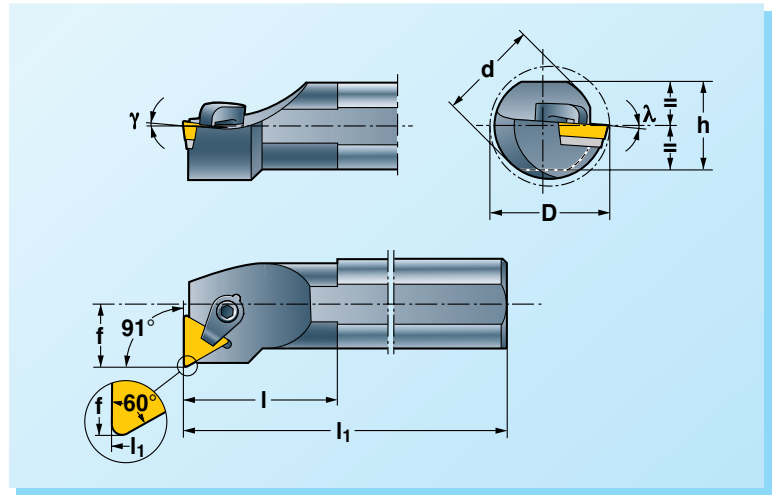

B

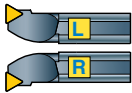
	d	h	l	l ₁	f	D _{min}	γ	λ							TPGN TPUN TCGR TPGR TPMR	Page: Seite: Sida: B185, B192
																
S10K-CTFC R/L 06M	10	9	20	125	6.5	12	0°	-7°	-	-	CS70	-	-	NY 1.5	0601 ..	
S12M-CTFP R/L 09M	12	11	25	150	9	16	6°	-3°	-	-	CS70	-	-	NY 1.5	0902 ..	
S16R-CTFP R/L 11M S20S-CTFP R/L 11M	16 20	15 18	25 30	200 250	10.5 12.5	20 25	5°	0°	-	-	-	SH12T SH12T	6S-12 6S-12	NY 3	1103 ..	
S25T-CTFP R/L 16M S32U-CTFP R/L 16M S40U-CTFP R/L 16M	25 32 40	23 30 37	35 40 45	300 350 350	14.5 18.5 22.5	29 38 46	5°	0°	- U323S U323S	- RS2 RS2	- - -	SH12 SH52K SH52K	6S-12 6S62K1 6S62K1	NY 4	1603 ..	
S40U-CTFP R/L 22M S50V-CTFP R/L 22M S60W-CTFP R/L 22M	40 50 60	37 47 57	50 55 60	350 400 450	26 29 43	54 64 77	5°	0°	U324S U324S U324S	RS3 RS3 RS3	- - -	SH52K SH52 SH52	6S62K1 6S62 6S62	NY 4	2204 ..	

CTKC R/L CTKP R/L

Recommendations
Empfehlungen
Rekommendationer

Page: Seite: Sida:

B12-B14, B19

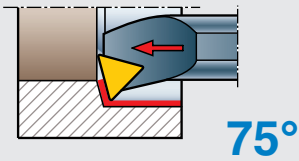

75°

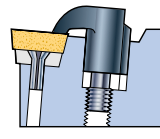

C

The drawing shows right-hand version. Left-hand version reversed.
Die Zeichnung zeigt Rechtsausführung. Linksausführung umgekehrt.
Ritningen visar högerutförande. Vänsterutförande spegelvänt.

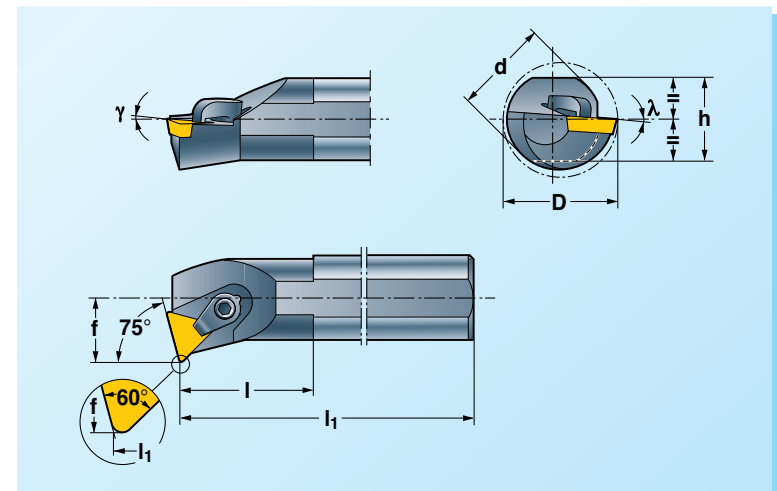

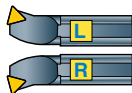
	d	h	l	l ₁	f	D _{min}	γ	λ							TPGN TCGR TPGR TPMR	Page: Seite: Sida: B185, B192
																
S10K-CTKC R/L 06M	10	9	20	125	6.5	12	-2°	-7°	-	-	CS70	-	-	NY 1.5	0601 ..	
S12M-CTKP R/L 09M	12	11	25	150	9	16	6°	-3°	-	-	CS70	-	-	NY 1.5	0902 ..	

Ordering example:

Bestellbeispiel: **S40U-CTFPR 22M**

Beställningsexempel:

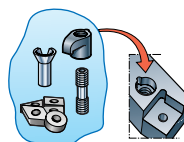

Spare parts shown in the coloured columns are supplied assembled in each tool.

Die in den farbigen Spalten aufgeführten Ersatzteile sind in den Werkzeugen montiert.

Reservdelar i de färgade kolumnerna ingår monterade i varje verktyg.

CSKP R/L

Recommendations
Empfehlungen
Rekommendationer

Page: Seite: Sida:

B12-B14, B19

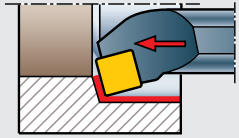

75°

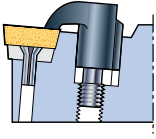

C

B

The drawing shows right-hand version. Left-hand version reversed.
Die Zeichnung zeigt Rechtsausführung. Linksausführung umgekehrt.
Ritningen visar högerutförande. Vänsterutförande spegelvänt.

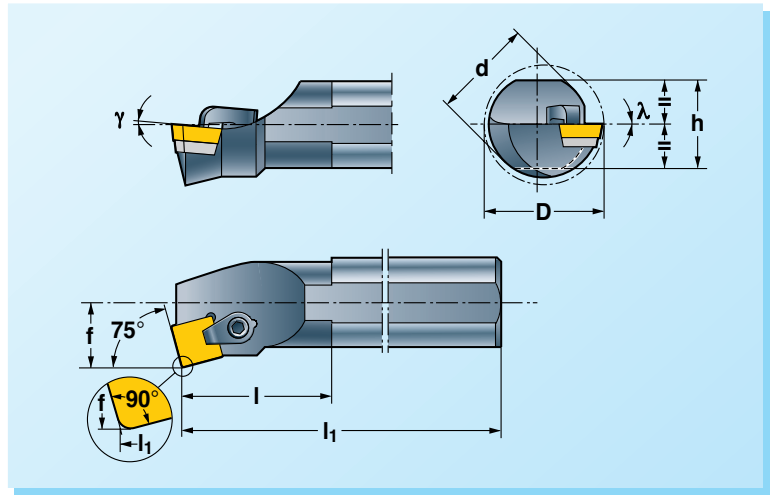

	d	h	l	l ₁	f	D _{min}	γ	λ						SPGN SPUN SPGR SPMR	Page: Seite: Sida: B185, B192
S16R-CSKP R/L 09M S20S-CSKP R/L 09M	16 20	15 18	30 35	200 250	10.5 12.5	20 25	5°	0°	—	—	SH12T SH12T	6S12 6S12	NY3	0903 . .	
S25T-CSKP R/L 12M S32U-CSKP R/L 12M S40U-CSKP R/L 12M	25 32 40	23 30 37	45 50 55	300 350 350	14.5 18.5 22.5	29 38 46	5°	0°	U424S U424S	RS2 RS2	SH12 SH52K SH52K	6S12 6S62K1 6S62K1	NY3 NY4 NY4	1203 . .	
S40U-CSKP R/L 19M S50V-CSKP R/L 19M S60W-CSKP R/L 19M	40 50 60	37 47 57	55 60 70	350 400 450	26 29 43	54 63.5 77	5°	0°	U426S U426S U426S	RS3 RS3 RS3	SH52K SH52 SH52	6S62K1 6S62 6S62	NY4	1904 . .	

Ordering example:

Bestellbeispiel: **S40U-CSKPR 19M**

Beställningsexempel:

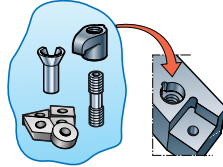

Spare parts shown in the coloured columns are supplied assembled in each tool.

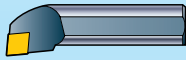

Die in den farbigen Spalten aufgeführten Ersatzteile sind in den Werkzeugen montiert.

Reservdelar i de färgade kolumnerna ingår monterade i varje verktyg.

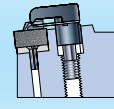
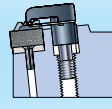

**Ceramics
Keramik
Keramik**

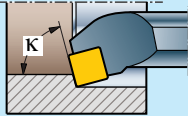

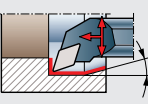
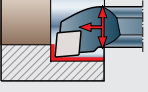
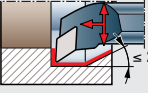
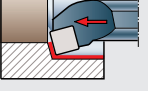
						Page Seite Sida
		40	50	60		
 107,5° ≤ 15°	CDQN R/L (C) CDQN R/L (P)		15	15		B118
 95°	CCLN R/L (C) -	12	12			B118
 93° ≤ 27°	CDUN R/L (C) CDUN R/L (P)		15	15		B119
 75°	CSKN R/L (C) -	12	12			B119

(C) – Clamping set with chip breaker.
(P) – Clamping set with thrust plate.

(C) – Spännsystem mit Spanbrecher.
(P) – Spännsystem mit Druckplatte.

(C) – Spännsats med spånbrytare.
(P) – Spännsats med tryckplatta.

B

CDQN R/L (C) CDQN R/L (P)

Recommendations
Empfehlungen
Rekommendationer

Page: Seite: Sida:

B12-B14, B20

Ceramics – Keramik – Keramik

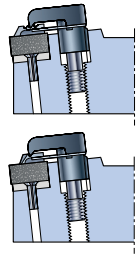
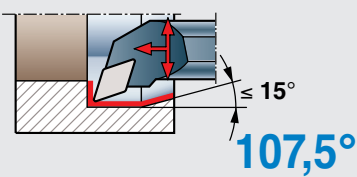

C

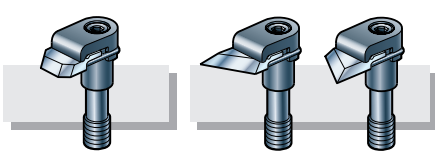

(P)

Thrust plate – Druckplatte
Tryckplatta

(C)

Chip breaker – Spanbrecher
Spånbytare

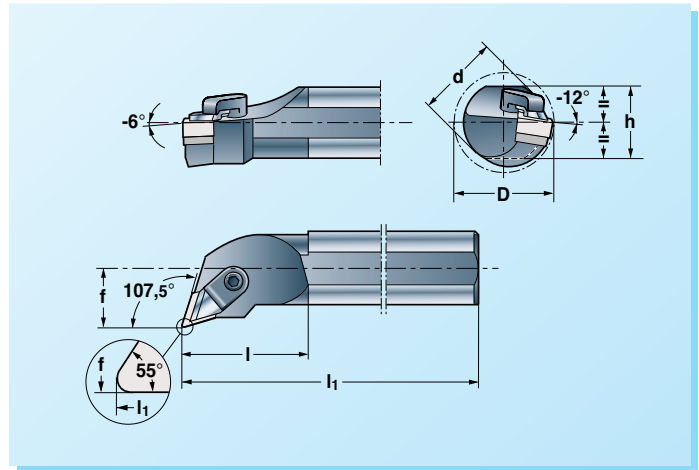

The drawing shows right-hand version. Left-hand version reversed.
Die Zeichnung zeigt Rechtsausführung. Linksausführung umgekehrt.
Ritningen visar högerutförande. Vänsterutförande spegelvänt.

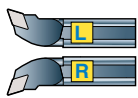

S50V-CDQN R/L 15C
S60W-CDQN R/L 15C

d

h

l_1

f

D_{min}

l

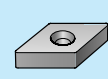

Page:
Seite:
Sida: **B190-B192**

DNGN

S50V-CDQN R/L 15P
S60W-CDQN R/L 15P

d

h

l_1

f

D_{min}

l

UDN1503¹⁾
(UDN1506)²⁾

RS3

CS834 RC⁴⁾

CS834 LC⁴⁾

–

–

CS831P

NY 4

1507 . .¹⁾
(1504 . .)²⁾

CCLN R/L (C)

–

Recommendations
Empfehlungen
Rekommendationer

Page: Seite: Sida:

B12-B14, B20

Ceramics – Keramik – Keramik

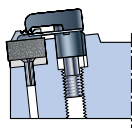
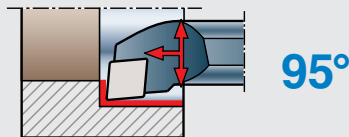

C

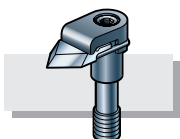

(C)

Chip breaker – Spanbrecher
Spånbytare

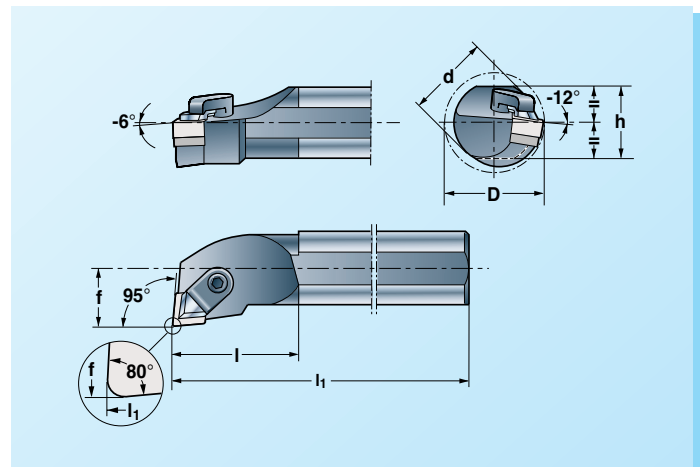

The drawing shows right-hand version. Left-hand version reversed.
Die Zeichnung zeigt Rechtsausführung. Linksausführung umgekehrt.
Ritningen visar högerutförande. Vänsterutförande spegelvänt.

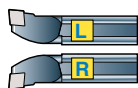

S40U-CCLN R/L 12C
S50V-CCLN R/L 12C

d

h

l_1

f

D_{min}

l



Page:
Seite:
Sida: **B190-B192**

CNGN

1207 . .¹⁾
(1204 . .)²⁾



Chip breaker/thrust plate, page:
Spanbrecher/Druckplatte, Seite:
Spånbytare/tryckplatta, sid:

B120

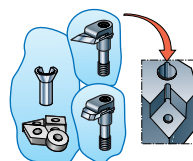

Spare parts shown in the coloured columns are supplied assembled in each tool.

Die in den farbigen Spalten aufgeführten Ersatzteile sind in den Werkzeugen montiert.

Reservdelar i de färgade kolumnerna ingår monterade i varje verktyg.

Ordering example:

Bestellbeispiel: **S40-CCLNR 12C**

Beställningsexempel:

CDUN R/L (C)
CDUN R/L (P)

Recommendations
Empfehlungen
Rekommendationer

Page: Seite: Sida:
B12-B14, B20

Ceramics – Keramik – Keramik

$\leq 27^\circ$ **93^\circ**

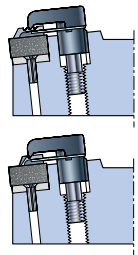

C

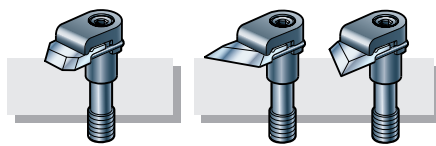

(P)

Thrust plate – Druckplatte
Tryckplatta

(C)

Chip breaker – Spanbrecher
Spånbrytare

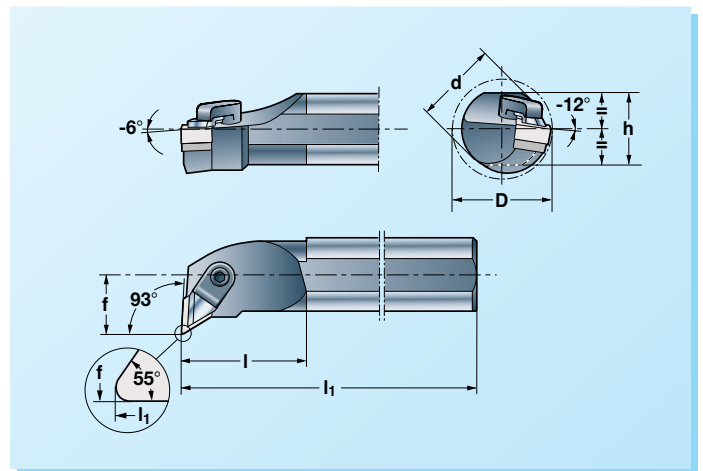

The drawing shows right-hand version. Left-hand version reversed.
Die Zeichnung zeigt Rechtsausführung. Linksausführung umgekehrt.
Ritningen visar högerutförande. Vänsterutförande spegelvänt.

	d	h	l ₁	f	D _{min}	l							Page: Seite: Sida: B190-B192	
													DNGN	
S50V-CDUN R/L 15C S60W-CDUN R/L 15C	50 60	47 57	400 450	35 43	70 77	65 70	UDN1503 ¹⁾ (UDN1506) ²⁾	RS3	CS834 RC ⁴⁾	CS834 LC ⁴⁾	–	–	NY 4	1507 . . ¹⁾ (1504 . .) ²⁾
S50V-CDUN R/L 15P S60W-CDUN R/L 15P	50 60	47 57	400 450	35 43	70 77	65 70	UDN1503 ¹⁾ (UDN1506) ²⁾	RS3	–	–	CS831P	–	NY 4	1507 . . ¹⁾ (1504 . .) ²⁾

CSKN R/L (C)

Recommendations
Empfehlungen
Rekommendationer

Page: Seite: Sida:
B12-B14, B20

Ceramics – Keramik – Keramik

75^\circ

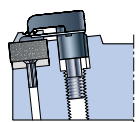

C

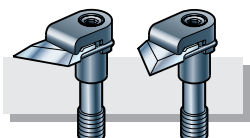

(C)

Chip breaker – Spanbrecher
Spånbrytare

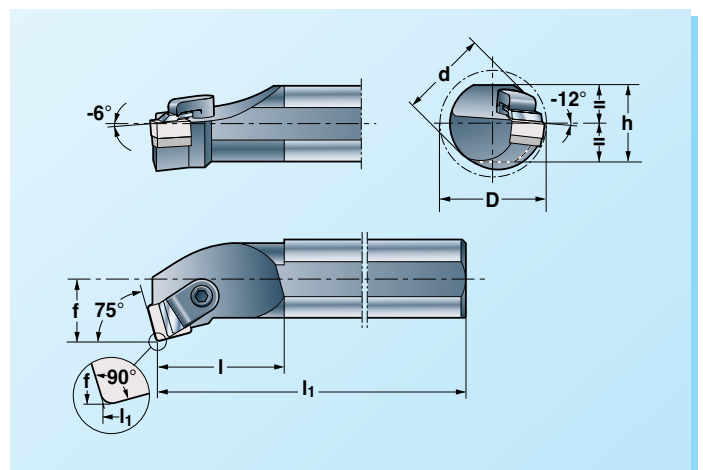

The drawing shows right-hand version. Left-hand version reversed.
Die Zeichnung zeigt Rechtsausführung. Linksausführung umgekehrt.
Ritningen visar högerutförande. Vänsterutförande spegelvänt.

	d	h	l ₁	f	D _{min}	l							Page: Seite: Sida: B190-B192	
													SNGN	
S40U-CSKN R/L 12C S50V-CSKN R/L 12C	40 50	37 47	350 400	27 35	70 70	55 65	U414ST ¹⁾ (U414SK) ²⁾	RS308	CS832 RC ⁴⁾	CS832 LC ⁴⁾	–	–	NY4	1207 . . ¹⁾ (1204 . .) ²⁾

¹⁾ Standard delivery for inserts with 7.94 mm thickness.
²⁾ Separate delivery for inserts with 4.76 mm thickness.

¹⁾ Standardlieferung für Schneiden mit 7,94 mm Dicke.
²⁾ Lieferung auf besondere Bestellung für Schneiden mit 4,76 mm Dicke.

¹⁾ Standardleverans för skär med 7,94 mm tjocklek.
²⁾ Separat leverans för skär med 4,76 mm tjocklek.

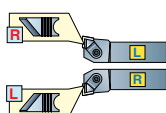

- ⁴⁾ Chip breaker in R-style is used in L-holders.
Chip breaker in L-style is used in R-holders.
- ⁴⁾ Spånbrytare i R-Ausführung wird in L-Halter verwendet.
Spånbrytare in L-Ausführung wird in R-Halter verwendet.
- ⁴⁾ Spånbrytare i R-utförande används i L-hållare.
Spånbrytare i L-utförande används i R-hållare.

Chip breaker/thrust plate for turning tool holders with ceramic inserts
 Spanbrecher/Druckplatte für Drehklemmhalter mit Keramikschniden
 Spånbrytare/tryckplatta för svarvhållare med keramiska vändskär

Chip breaker – Spanbrecher – Spånbrytare

B

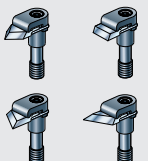
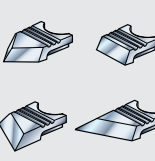

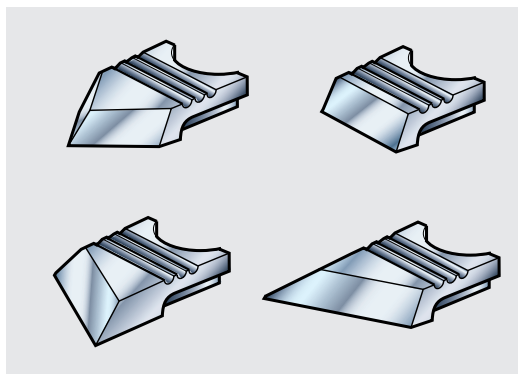
	
CS 822 C	SB 82
CS 832 C	SB 82
CS 832 RC	SB 82 R
CS 832 LC	SB 82 L
CS 833 C	SB 83 C
CS 834 RC	SB 84 DR
CS 834 LC	SB 84 DL
CS 835 C	SB 85 C
CS 836 RC	SB 86 R
CS 836 LC	SB 86 L
CS 837 RC	SB 87 R
CS 837 LC	SB 87 L



Ordering example:
 Bestellbeispiel: **SB 83 C**
 Beställningsexempel:

Tool holders, page:
 Klemmhalter, Seite: **B118-B119**
 Verkygshållare, sid:

Thrust plate – Druckplatte – Tryckplatta

	
CS 821P	TP 1
CS 831P	TP 1

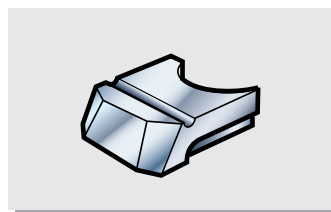

Ordering example:
 Bestellbeispiel: **TP 1**
 Beställningsexempel:

Tool holders, page:
 Klemmhalter, Seite: **B118-B119**
 Verkygshållare, sid:

Built-in measurement for MIRCONA insert seat type C
 Einbaumassen für MIRCONA Schneidsitze Typ C
 Inbyggnađsmått för MIRCONA skårlåge typ C

Size
 Grösse 06 CM
 Storlek

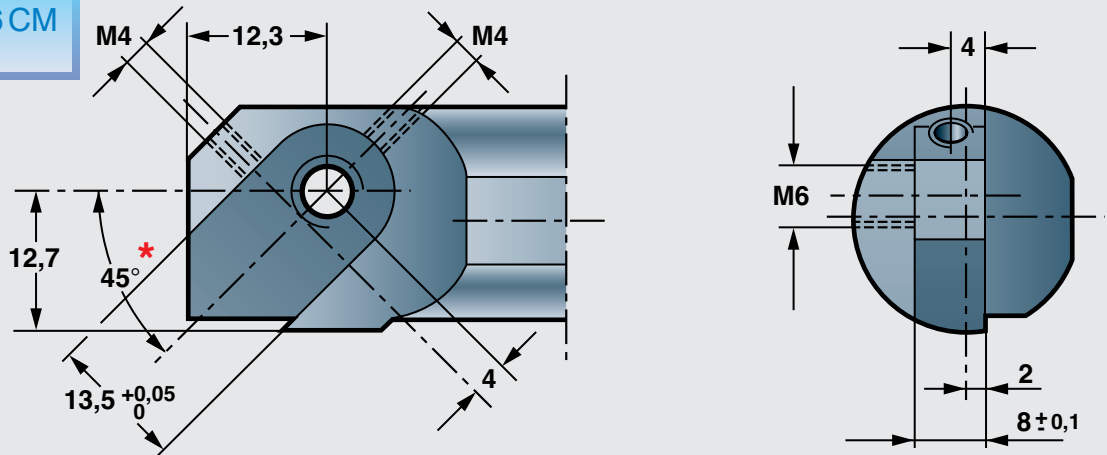

Size
 Grösse 07 CM
 Storlek

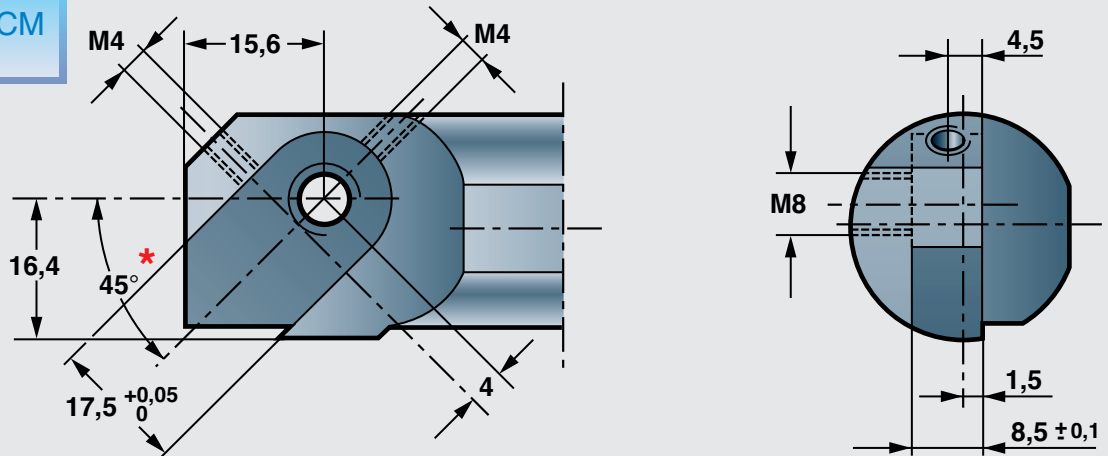

* The angle 45° of the recess gives the tool an approach angle of 75°. By modifying the angle of the recess, other approach angles can be achieved.

* Der Winkel 45° der Aussparung gibt dem Werkzeug einen Stellwinkel von 75°. Durch die Modifizierung des Aussparungswinkels können andere Stellwinkel erreicht werden.

* Vinkeln 45° hos urtaget ger verktyget en ställvinkel på 75°. Genom att förändra vinkeln hos urtaget kan andra ställvinklar erhållas.

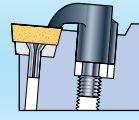
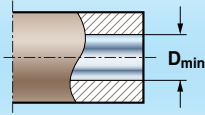
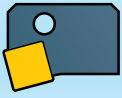

B

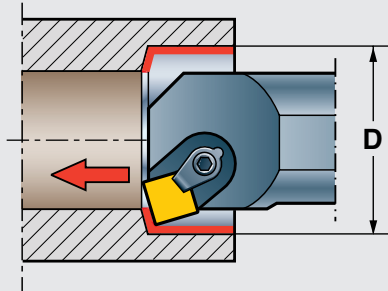

Size Grösse Storlek	06 CM	07 CM
Type Typ Typ	CSKP	CSKP
D-min	26	32

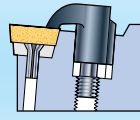

CSKP R/L

Recommendations
Empfehlungen
Rekommendationer

Page: Seite: Sida:

B12-B14, B18

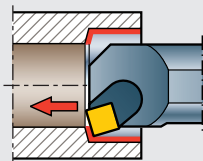



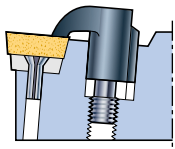

75°

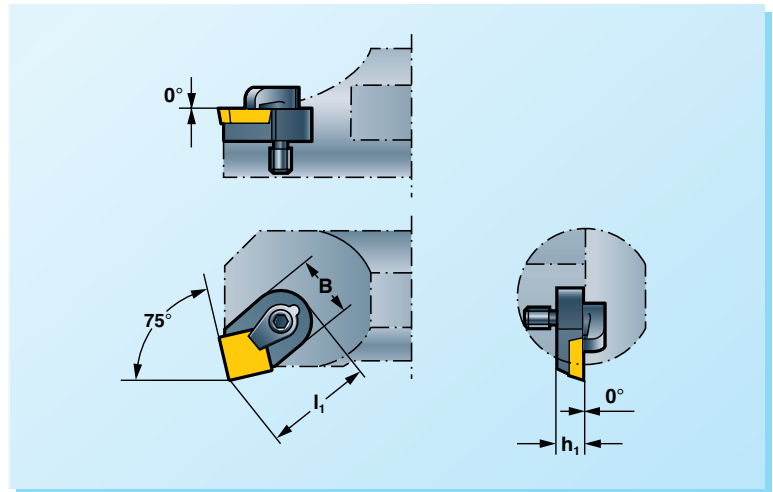

C



The drawing shows right-hand version. Left-hand version reversed.
Die Zeichnung zeigt Rechtsausführung. Linksausführung umgekehrt.
Ritningen visar högerutförande. Vänsterutförande spegelvänt.

	h_1	l_1	B				SPGN 	Page: Seite: Sida:
CSKPR/L 06CMX09	6	25	13,5	SH51	6S61K	NY 3	0903 . .	B185, B192
CSKPR/L 07CMX12	7	32	17,5	SH52K	6S62K	NY4	1203 . .	

Ordering example:
Bestellbeispiel: **CSKPR 06CMX09**
Beställningsexempel:

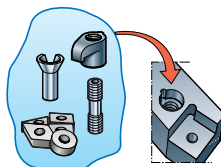



Spare parts shown in the coloured columns are supplied assembled in each tool.

Die in den farbigen Spalten aufgeführten Ersatzteile sind in den Werkzeugen montiert.

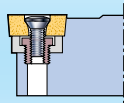
Reservdelar i de färgade kolumnerna ingår monterade i varje verktyg.

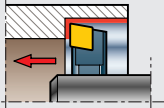
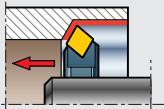
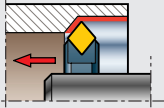
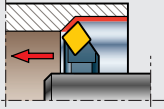

					Page Seite Sida
		8	10	12	
	90° SCAC R/L	06	06	09	B124
	60° SCEC R/L	06	06	09	B124
	50° SCMC N	06	06	09	B125
	45° SCDC R/L	06	06	09	B125

B

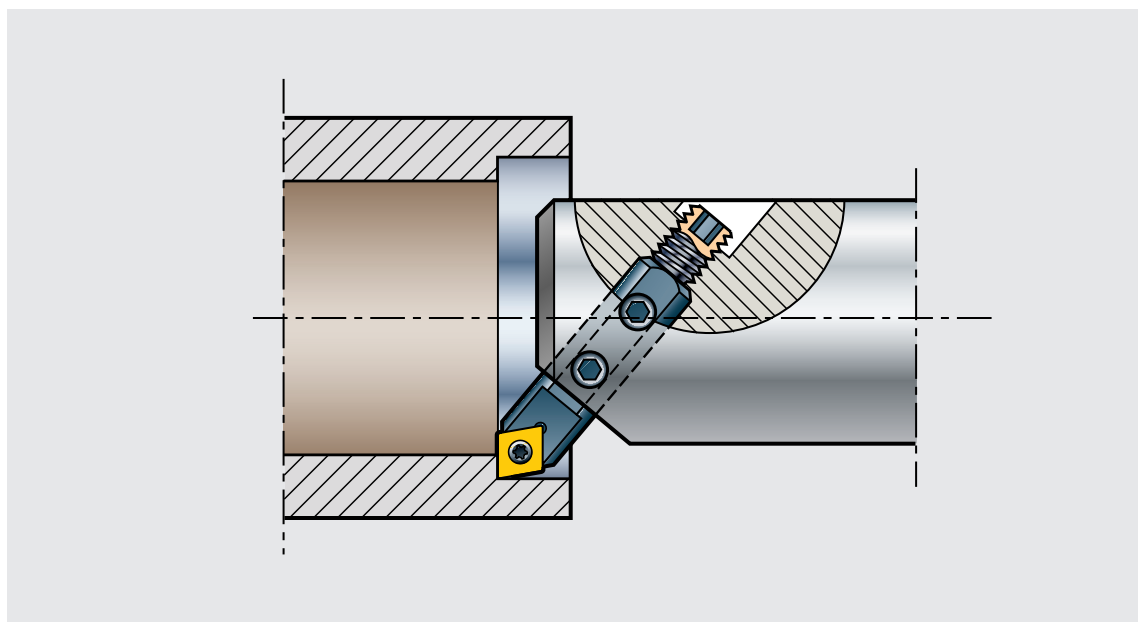

SCAC R/L

Recommendations
Empfehlungen
Rekommendationer

Page: Seite: Sida:

B12-B14, B18

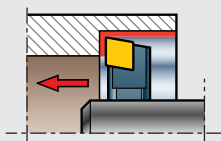

90°

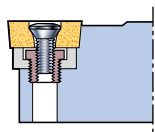

S

B

The drawing shows right-hand version. Left-hand version reversed.
Die Zeichnung zeigt Rechtsausführung. Linksausführung umgekehrt.
Ritningen visar högerutförande. Vänsterutförande spegelvänt.

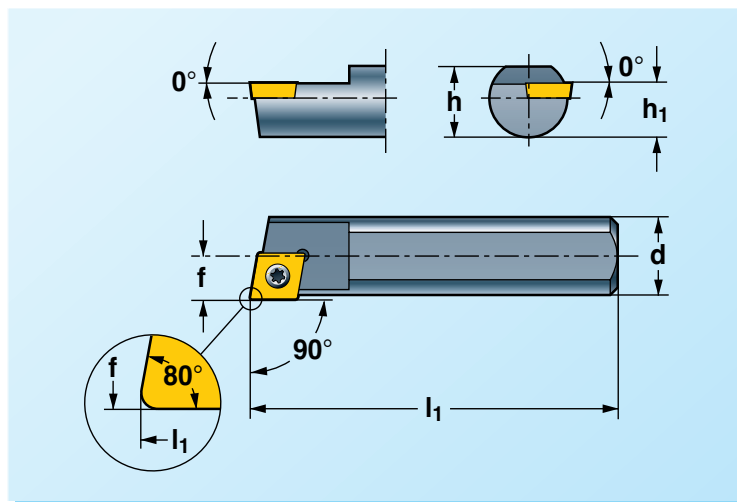

h_1	h	d h_8	f	l_1
6	7	8	4,3	32
7	9	10	5,3	50
8	11	12	6,3	60



torx

CCMW *
CCMT
CCXT



Page:
Seite:
Sida:

B179-B184

S08A-SCAC R/L 06

S10C-SCAC R/L 06

S12D-SCAC R/L 09

FTX072505

NY7X

0602 . .

FTX153507

NY15X

0903 . .

SCEC R/L

Recommendations
Empfehlungen
Rekommendationer

Page: Seite: Sida:

B12-B14, B18

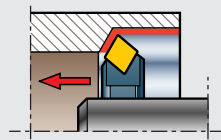

60°

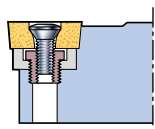

S

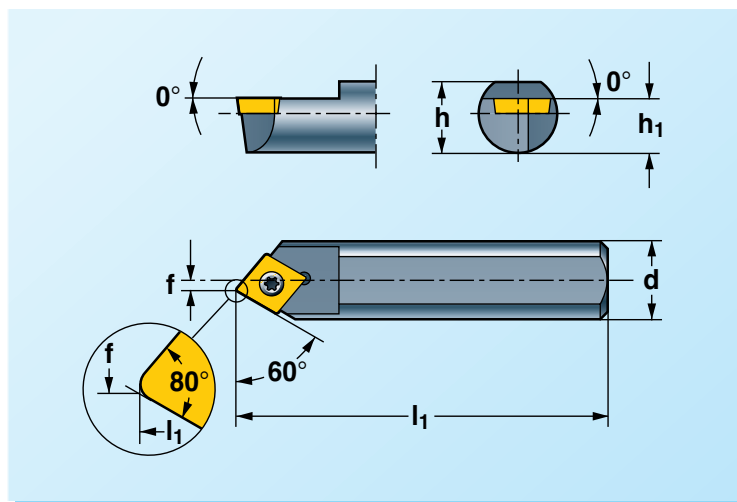

The drawing shows right-hand version. Left-hand version reversed.
Die Zeichnung zeigt Rechtsausführung. Linksausführung umgekehrt.
Ritningen visar högerutförande. Vänsterutförande spegelvänt.



h_1	h	d h_8	f	l_1
6	7	8	1,5	32
7	9	10	2,4	50
8	11	12	2,3	60



torx

CCMW *
CCMT
CCXT



Page:
Seite:
Sida:

B179-B184

S08A-SCEC R/L 06

S10C-SCEC R/L 06

S12D-SCEC R/L 09

FTX072505

NY7X

0602 . .

FTX153507

NY15X

0903 . .